

Date 2023/10/7

Condition Carpet Asphalt

Track Situation Flat Bump

Track Course RCマニアックスアリーナ

Traction High Medium Low

Track Size Small Medium Large X-Large

Driver Takashi Kato

Temperature Humidity

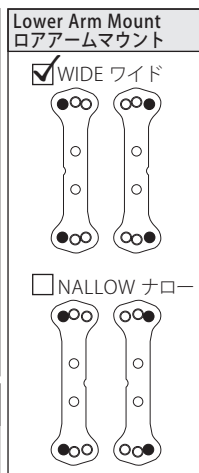
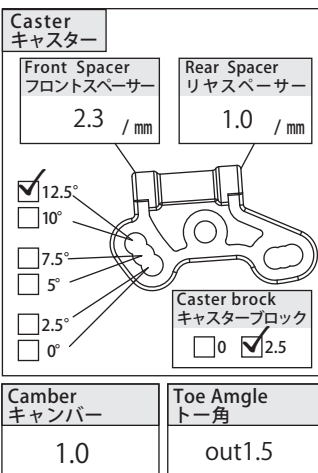
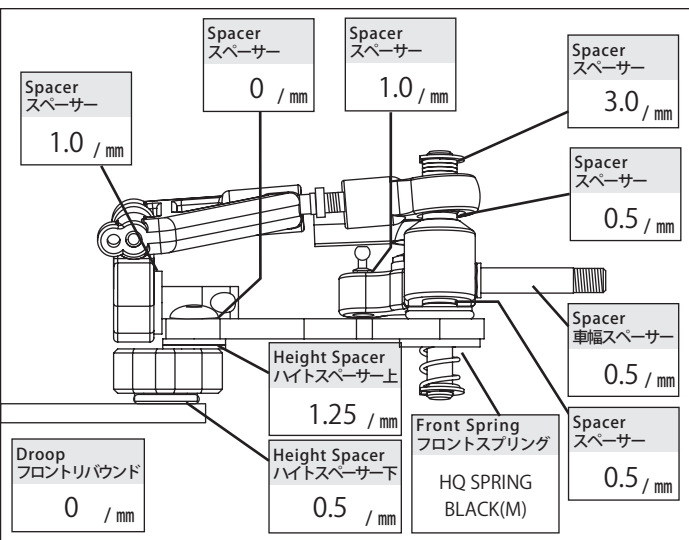

- Kingpin Oil HQ KINGPIN OIL MEDIUM
- Upper Arm AK12X
- Upper Arm Block AK12X
- Lower Arm AK12X
- Steering Block AK12X

Front Arm Support Plate No Yes /mm

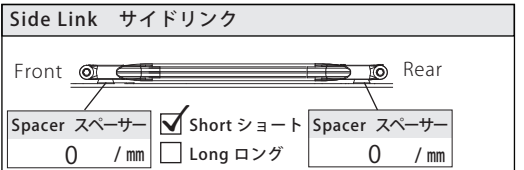
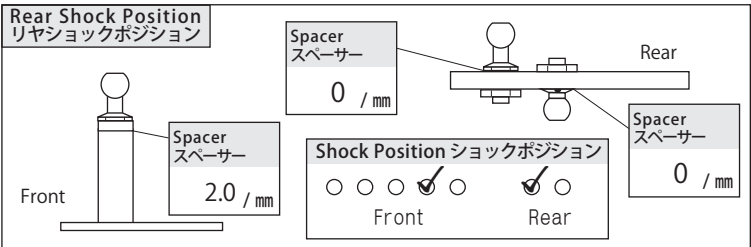
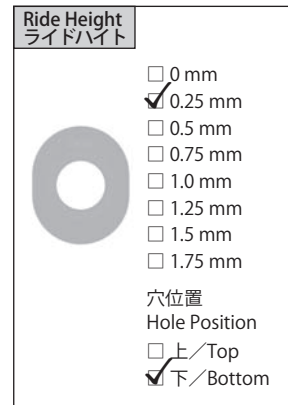
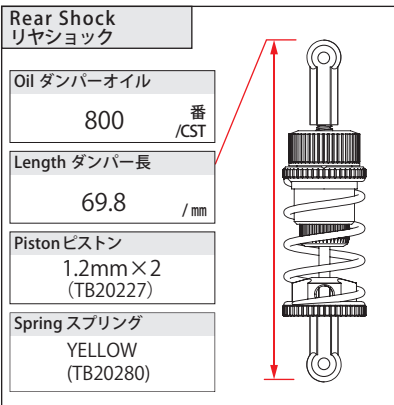

- Solid Carbon Steel
- Ball Diff
- Hard Soft

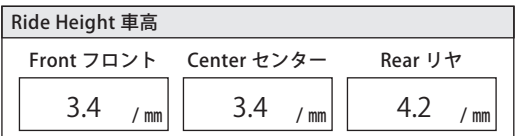
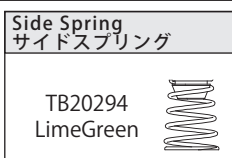
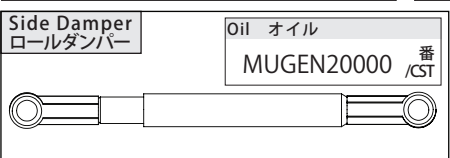

Motor G★STYLE V3 21.5 Type T / 40度

Transmitter SANWA M17

Tread Front 171.5 /mm

Spur Gear 76 / 40

Receiver RX-493

Battery TRION 3800HV

Servo SANWA PGS-HR (Type2)

Electric Speed Controller HW

Servohorn XRAY

Body TeamBomber LMP-KETTER (0.4 mm) 39 mm

Main Chassis AK12X (Aluminum)

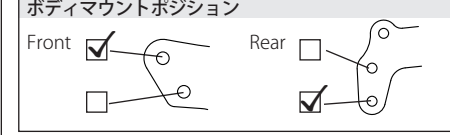

Lower Brace AK12X (Aluminum)

Back Plate TB20205 (SOFT)

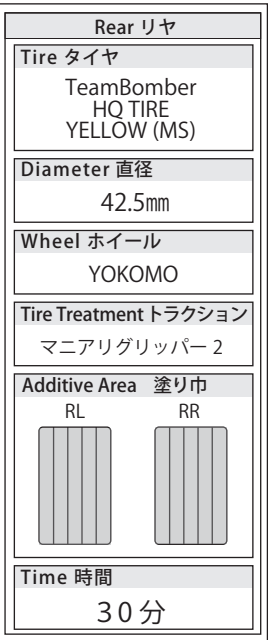
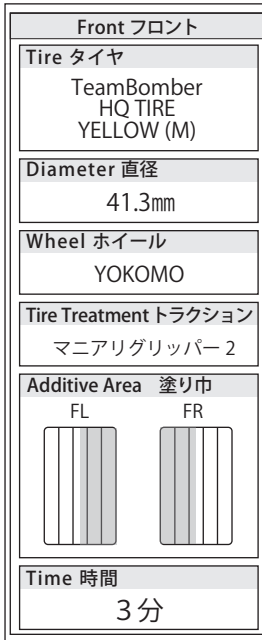

MEMO TB20209S AK12 モーターマウント S
TB20230 チタンコートダンパーシャフト
TB20264 フロントサマウントプレート
TB20265 アルミ製リヤホイールビス
TB20266 AK12 キャスターブロックサポート
TB20267A 3D ボディバンパー V2
TB20268 HQ フロントスプリングリテーナー

※SQUARE 製チタンビス使用

Ver1.0